

ORBITIZER

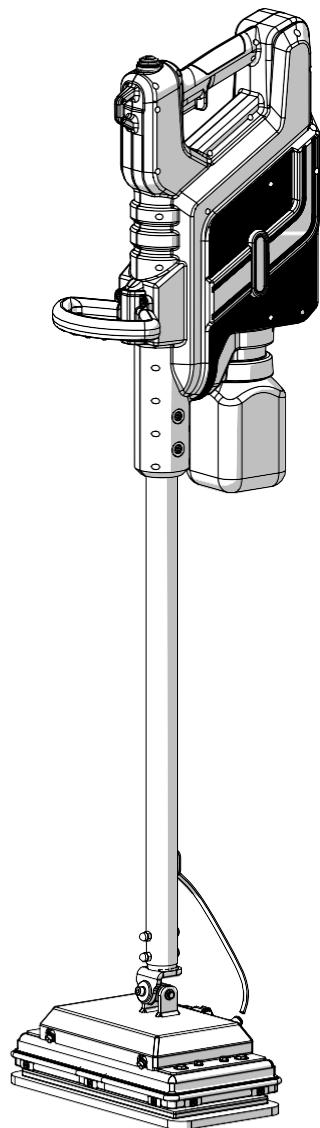

COMMERCIAL SINGLE DISC MACHINES

USE AND MAINTENANCE MANUAL

 **FIMAP**[®]



ORIGINAL INSTRUCTIONS DOC. 10100648 - Ver. AA - 10-2020

CONTENTS

CONTENTS	3
GENERAL SAFETY REGULATIONS	4
RECHARGING THE BATTERY	4
USING THE MACHINE	6
DEACTIVATION OF THE MACHINE	8
MAINTENANCE	8
TRANSPORT	9
GENERAL DESCRIPTION	10
SYMBOLS USED IN THE MANUAL.....	10
DEFINITION OF LEVELS OF WARNING.....	10
PURPOSE AND CONTENT OF THE MANUAL.....	10
TARGET GROUP.....	10
PRESERVATION OF THE USER.....	11
ON CONSIGNMENT OF THE MACHINE.....	11
INTRODUCTORY COMMENT.....	11
IDENTIFICATION DATA.....	11
TECHNICAL DESCRIPTION.....	11
INTENDED USE.....	11
SAFETY.....	11
SERIAL NUMBER PLATE.....	11
TECHNICAL DATA	12
MAIN MACHINE COMPONENTS	12
LABELS USED ON THE MACHINE	13
PREPARATION OF MACHINE	13
HANDLING THE PACKAGED MACHINE.....	13
HOW TO UNPACK THE MACHINE.....	13
HOW TO MOVE THE MACHINE.....	14
MACHINE SAFETY.....	14
HOW TO FIT THE CONTROL HANDLE.....	14
HOW TO FIT THE BRUSH HEAD BODY.....	14
TYPE OF BATTERY TO BE USED.....	15
BATTERY MAINTENANCE AND DISPOSAL.....	15
INSERTING THE BATTERY INTO THE MACHINE.....	15
RECHARGING THE BATTERY.....	15
FILLING THE SOLUTION TANK.....	16
ASSEMBLING THE ABRASIVE PAD.....	16
PREPARING TO WORK	17
STARTING WORK	17
BATTERY CHARGE LEVEL INDICATOR.....	17
ALARM SIGNALLING DEVICE.....	18
AT THE END OF THE WORK	18
ROUTINE MAINTENANCE	18
DISPOSAL	19
CHOOSING AND USING THE PAD	19
TROUBLESHOOTING	20
EC DECLARATION OF CONFORMITY	21

GENERAL SAFETY REGULATIONS

The following symbols are used to indicate any potentially hazardous situations. Always read this information carefully and take the necessary precautions to protect any people and/or objects that may be present.

Operator cooperation is paramount for accident prevention. No accident prevention programme can be effective without the full cooperation of the person directly responsible for the machine's operation. Most accidents that occur at the workplace, during work activities, or while in transit, are caused by the failure to respect the most basic safety regulations. An attentive, careful operator is most effective guarantee against accidents and is fundamental in order to implement any prevention programme.



DANGER: indicates an imminent dangerous situation that, unless avoided, will result in death or serious injuries.



WARNING: Indicates a potentially dangerous situation that, unless avoided, could cause death or serious injury.



ATTENTION: Indicates a potentially dangerous situation that, unless avoided, could cause slight or moderate injuries.

RECHARGING THE BATTERY





DANGER:

- If the battery charger power cable is damaged or broken, it should be replaced by the manufacturer or authorized service personnel, or else by another qualified person, in order to protect against hazards.
- The socket for the battery charger cable must have a prescribed earth connection.
- Keep sparks, flames, and incandescent materials at a safe distance from the battery.
- Only carry out the procedure in well ventilated areas and away from open flames.
- Before charging check that the base of the battery charger is not damaged, and if it is damaged do not use it and contact technical assistance.
- Before starting to charge the batteries, check there is no stagnant water or humidity in the on-board battery charger socket.
- Before charging check that the electric cable that connects the battery charger to the mains is not damaged, and if it is damaged do not use it and contact technical assistance.
- Do not disconnect the direct current cable of the battery charger from the socket of the machine when the battery charger is operating. This is necessary to prevent electric arcs forming. To disconnect the battery charger when it is charging, first disconnect the alternating current power cable.
- Recharge the battery (code. 443147) with the battery charger (code. 440807), both included in the packaging; do not use any other type of battery charger.
- The battery should be removed from the appliance before it has run down.

 **WARNING:**

- Do not use incompatible battery chargers since they could damage the batteries and potentially cause a fire.
- Keep a safe distance from flames or sparks.
- Before using the battery charger, make sure that the frequency and voltage indicated on the rating plate match the mains voltage.
- Keep the battery charger's cable at a safe distance from any hot surfaces.
- Do not smoke near the battery charger, during the charging cycle.
- Carefully read the user manual of the battery charger you want to use before recharging.
- Do not attempt to open the battery for any reason whatsoever. Avoid any contact with the liquid that seeps out of damaged batteries. If necessary, rinse the area of skin which came into contact with the liquid in water; in case of contact with eyes, rinse thoroughly and seek medical advice.
- Do not let the battery get dirty or wet.
- The battery must not be exposed to excessive heat (e.g. rays of sunshine, flames, etc.). Do not leave the battery in places where the temperature could exceed 40°C.
- The battery contacts must not touch metal parts, to avoid any risk of short-circuits.
- The battery must be kept far from metal objects, to avoid any risk of short-circuits.
- Do not throw the battery into the fire.
- Do not throw the battery away with domestic waste; respect the disposal regulations in force in the country where the appliance is used.
- Always recharge the battery at a room temperature between 10°C and 40°C. Recharge the battery using the power supply unit supplied with the appliance. Do not attempt to recharge damaged batteries.
- Only use the power supply unit delivered with the appliance to recharge the battery supplied by the manufacturer or by a specialized technician. Other batteries could explode, causing harm to people and damage to property.
- Do not use the battery charger in potentially explosive environments.
- The battery charger contacts must not touch metal parts, to avoid any risk of short-circuits.
- Never attempt to recharge the primary cell batteries: danger of explosion.
- Never attempt to recharge damaged batteries.
- Every time you want to use the battery charger and the battery, first make sure they are not damaged. Do not use damaged appliances. Have faulty parts repaired by the staff of a technical assistance center.
- Have any faulty supply wires replaced immediately.
- Do not let the power supply unit get dirty or wet.
- Do not open the power supply unit.
- Do not connect the power supply unit to probes.
- The batteries must be clean and dry when they are inserted in the battery charger. Do not use the battery charger if the battery holder support is dirty or wet.

 **ATTENTION:** the battery charger must only be used in a covered place.

 **ATTENTION:** read this manual before using the appliance or carrying out any maintenance work.



ATTENTION: if the battery is handled in the wrong way, it could explode or release acids. This could cause burns and injuries to the people nearby.



ATTENTION: when the battery is run down or damaged, respect the disposal regulations in force in the country of use.

USING THE MACHINE



DANGER:

- In case of danger act promptly by removing the battery at the rear of the machine.
- If the machine is used in dangerous areas (e.g. petrol stations), the relative safety standards must be observed.
- It is forbidden to use the machine in environments with a potentially explosive atmosphere.



WARNING:

- The machine must be exclusively used by authorized, trained personnel.
- Children must be supervised to ensure they do not play with the machine.
- Always use the machine in compliance with its intended use, taking into consideration local conditions and looking out for the presence of others when working, especially children.
- This machine should not be used by persons (including children) with physical, sensory or mental impairments and by persons with little experience and/or little knowledge of the machine itself.
- The machine is not suitable for cleaning rough or uneven floors. Do not use the machine on slopes.
- In the event of a fire, use a powder extinguisher. Do not use water.
- Adapt the speed to the adhesion conditions.
- Do not use the machine if you do not have the requisite knowledge or authorisation.
- Operators must receive adequately instructions on the use of the machine.
- Do not use the machine if these safety warnings and the machine user manual have not been read and understood.
- Do not use the machine under the influence of alcohol or drugs.
- Do not use the machine when using a mobile phone or other types of electronic devices.
- Do not use the machine if it is not working correctly.
- Do not use the machine in areas where there are inflammable vapours or liquids or combustible powders.
- Do not use the machine in environments that are too dark to see the controls or to use the machine safely.

 **ATTENTION:**

- Children must be supervised to ensure they do not play with the machine.
- During the working of the machine, pay attention to other people and especially to children.
- Read the labels on the machine carefully. Do not cover them for any reason, and replace them immediately if they become damaged.
- The machine must only be used and stored in an enclosed or covered environment.
- The machine must not be used or stored outdoors in damp conditions or directly exposed to rain.
- The machine does not cause harmful vibrations.
- Only use the machine in accordance with the instructions set out in these safety warnings and in the machine user manual.
- Always follow the instructions for mixing, use and disposal on the containers of the chemical substances.
- Always take appropriate measures to protect any individuals and/or objects that may be present while using this machine.
- Be careful to avoid collisions with shelving or scaffolding, above all if there is a risk of objects falling from heights.
- Do not place any liquid containers on the machine.
- The machine must only be used in temperatures ranging from +10 °C to +40 °C. The humidity level must be between 30% and 95%.
- When using detergents to clean the flooring, always follow the instructions and respect the warnings indicated on the containers' labels.
- Always use appropriate gloves and protective equipment when handling the detergents used to clean the floor.
- Avoid using the pad with the machine at a standstill so that it does not cause damage to the floor.
- Do not allow any objects to penetrate into the machine's openings. Do not use the machine if the openings are obstructed.
- Keep the machine's openings free of any dust, lint, hairs, or any other foreign materials that could reduce the airflow.
- Do not remove or alter any labels affixed to the machine.
- Only use the pad holders supplied with the machine or those specified in the section "CHOOSING AND USING THE PAD" on page 19. The use of other pads could compromise the safety of the machine.
- This machine has not been made for external use but internal locations only.
- Before starting to work check that there are no leaks.
- Before starting to work check that all the safety devices have been installed and are working correctly.
- Take all due precautions so that hair, jewellery, loose clothing do not get entangled in the machine's moving parts.
- Only use the machine in well-lit areas.

DEACTIVATION OF THE MACHINE

WARNING:

- Always protect the machine against sunlight, rain, and other atmospheric agents, both while it is stationary and while it is in function.
- Store the machine in a dry, sheltered place: this machine is only designed for use under dry conditions, and must not be used or stored outdoors under humid conditions.
- Do not park the machine near combustible materials, powders, gases or liquids.
- Stop the machine on a flat surface.
- If the machine is left unattended, it must be protected from any accidental movements.
- To prevent unauthorized use of the machine, the power supply must be disconnected by removing the battery at the rear of the machine.

ATTENTION:

- The machine must only be stored in temperatures ranging from +10 °C to +40 °C. The humidity level must be between 30% and 95%.

MAINTENANCE

DANGER:

- In order to avoid short-circuits when working in the vicinity of electrical components, do the following: avoid the use of non-insulated tools; do not place or allow metallic objects to fall upon the electrically powered components; remove any rings, watches and/or clothing with metallic parts that might come into contact with the electrically powered components.
- Before commencing any maintenance, cleaning or replacement of parts, the power supply must be disconnected by removing the battery at the rear of the machine.

WARNING:

- The cleaning and maintenance to be carried out by the user must not be performed by unsupervised children.
- Read all the relevant instructions carefully before performing any maintenance/repair operations.
- If the machine does not work properly, check this is not caused by failure to carry out maintenance. Otherwise, ask for intervention of the authorized technical assistance center.
- Restore all electrical connections after any maintenance interventions.

 **ATTENTION:**

- Avoid contact with moving parts. Do not wear loose clothing or jewellery and tie long hair back.
- Lift the machine with equipment that can sustain the weight to be lifted.
- Never tamper with the machine's protection devices for any reason; always follow the supplied routine maintenance instructions scrupulously.
- If any parts need to be replaced, always request ORIGINAL spare parts from an authorized Dealer or Retailer.
- In order to ensure the machine's safety and proper functionality, always have the scheduled maintenance interventions (specified in the appropriate section of this Manual) performed by authorized personnel or by an authorized Service Center.
- Do not wash the machine with direct jets of water, pressurized water or with corrosive substances, and do not wet it in the vicinity of electrical components.
- Have the machine checked by an authorized technical assistance center every year.
- When disposing of consumable materials, observe the laws and regulations in force. Once the machine has reached the end of its service life, the materials contained within it must be disposed of in an appropriate manner, keeping in mind that the machine itself has been built using fully recyclable materials.
- All repairs must be carried out by qualified personnel.
- Do not physically change the design characteristics of the machine.
- Use spare parts provided by authorized service centers.
- Wear personal protective equipment as required and as suggested in the manual.

TRANSPORT

 **WARNING:**

- Empty the solution tank before transporting the machine.
- Secure the device according to the directives in force in the country of use, so that it cannot slide or tip over when being transported.











 **ATTENTION:**

- Use caution when moving the machine under temperatures below freezing. Water in the solution tank or tubes could freeze and seriously damage the machine.





GENERAL DESCRIPTION

The descriptions contained in this document are not binding. The company therefore reserves the right to make any modifications at any time to elements, details, or accessory supply, as considered necessary for reasons of improvement or manufacturing/commercial requirements. The reproduction, even partial, of the text and drawings contained in this document is prohibited by law. **The company reserves the right to make any technical and/or supply modifications. The images are shown as reference only and are not binding as to the actual design and/or equipment.**

SYMBOLS USED IN THE MANUAL

	Open book symbol with an "i": Indicates the need to consult the instruction manual.
	Open book symbol: Tells the operator to read the user manual before using the device.
	Covered place symbol: The operations preceded by this symbol must always be carried out in a dry, covered area.
	Information symbol: Indicates additional information for the operator, to improve the use of the device.
	Warning symbol: Carefully read the sections preceded by this symbol meticulously following the instructions indicated for the safety of the operator and the device.
	Danger symbol (corrosive substances): The operator should always wear protective gloves to avoid the risk of serious injury to the hands caused by corrosive substances.
	Mandatory room ventilation symbol: Informs the operator that the room must be ventilated while the batteries are being recharged.
	Symbol indicating the compulsory use of protective gloves: Indicates that the operator should always wear protective gloves, to avoid the risk of serious injury to his hands from sharp objects.
	Recycling symbol: Tells the operator to carry out the operations in compliance with environmental regulations in force in the place where the appliance is being used.
	Disposal symbol: Carefully read the sections marked with this symbol for disposing of the appliance.

DEFINITION OF LEVELS OF WARNING

-  **DANGER:** indicates an imminent dangerous situation that, unless avoided, will result in death or serious injuries.
-  **WARNING:** Indicates a potentially dangerous situation that, unless avoided, could cause death or serious injury.
-  **ATTENTION:** Indicates a potentially dangerous situation that, unless avoided, could cause slight or moderate injuries.
-  **N.B.:** instructs the reader to pay particular attention to the topic that follows.

PURPOSE AND CONTENT OF THE MANUAL

The aim of this manual is to provide customers with all the information needed to use the machine in the safest, most appropriate and most autonomous way. This includes information concerning technical aspects, safety, operation, downtime, maintenance, spare parts and scrapping. The operators and qualified technicians must carefully read the instructions in this manual before carrying out any operations on the machine. If in doubt about the correct interpretation of instructions, contact your nearest FIMAP Customer Service Center to obtain the necessary clarifications.

TARGET GROUP

This manual is written both for operators and for qualified machine maintenance technicians. Operators must not perform operations that should be carried out by qualified technicians. The manufacturer is not liable for damages resulting from failure to comply with this veto.

PRESERVATION OF THE USER

The Use and Maintenance Manual must be stored in its special pouch close to the machine, protected from liquids and anything else that could compromise its legibility.

ON CONSIGNMENT OF THE MACHINE

When the machine is consigned to the customer, an immediate check must be performed to ensure all the material mentioned in the shipping documents has been received, and also to check the machine has not suffered damage during transportation. If this is the case, the carrier must ascertain the extent of the damage at once, informing our customer service office. It is only by prompt action of this type that the missing material can be obtained, and compensation for damage successfully claimed.

INTRODUCTORY COMMENT

A single-brush machine can only function well and work profitably if it is used correctly and kept in full working order, by carrying out the maintenance operations described in the attached documentation. We therefore suggest you read this instruction booklet carefully and read it again whenever difficulties arise while using the machine. If necessary, remember that our assistance service (organized in collaboration with our dealers) is always available for advice or direct intervention.

IDENTIFICATION DATA

For technical assistance or to request replacement parts, always give the model, the version and the serial number (written on the relevant plate).

TECHNICAL DESCRIPTION

The **Orbitizer** is a single-brush machine that uses the oscillation of an abrasive pad along with the chemical action of a water-detergent solution to clean a wide range of floors and types of dirt. **The machine must only be used for this purpose.**

INTENDED USE

This single-brush machine was designed and built for cleaning smooth, compact floors in commercial, civil and industrial environments by a qualified operator, in conditions that have been verified as safe. This single-brush machine is not suitable for cleaning carpets or rugs. This single-brush machine is designed to be used exclusively in closed or covered environments.

ATTENTION: the machine is not suitable for use in the rain, or under water jets.

IT IS FORBIDDEN to use the machine in environments with an explosive atmosphere to clean dangerous powders or flammable liquids. In addition, it is not suitable as a means of transport for people or objects.

SAFETY

Operator cooperation is paramount for accident prevention. No accident prevention programme can be effective without the full cooperation of the person directly responsible for machine operation. The majority of occupational accidents that happen either in the workplace or whilst moving are caused by failure to respect the most basic safety rules. An attentive, careful operator is most effective guarantee against accidents and is fundamental in order to implement any prevention programme.

SERIAL NUMBER PLATE

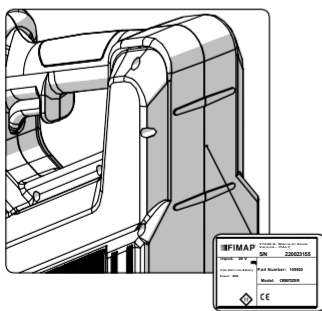

The serial number plate is positioned on the lower part of the machine body, where the general characteristics of the machine are displayed - the machine serial number in particular. The serial number is a very important piece of information and should always be provided together with any request for assistance or when purchasing spare parts. The serial number plate contains the following:

1. The commercial name of the machine, and the manufacturer's address.
2. The machine serial number.
3. The machine ID code.
4. The name used to identify the machine
5. The production date of the machine.

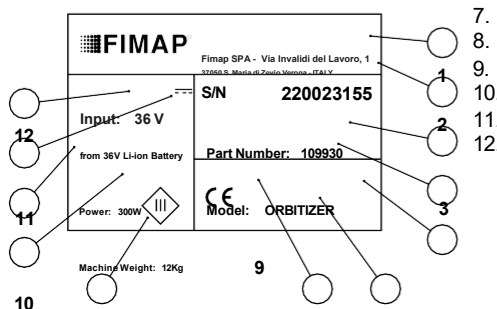

6. The IP protection rating of the machine.
7. The production order number of the machine.
8. The degree of insulation of the machine.
9. The electrical power of the machine.
10. The weight of machine when ready for use (GVW).
11. The type of electrical current used to power the machine.
12. The nominal voltage of the machine (expressed in V).

PO: 10280490 Date: 18/01/2018

IP24

4

Made in ITALY

5

7

6

TECHNICAL DATA

TECHNICAL DATA	U/M SI [KMS]	Orbitizer
Rated input power [EN 60335-2-67; IEC 62885-9]	KW	0,31
Maximum theoretical productivity	m ² /h	500
Working width [IEC 62885-9]	mm	340
Rated power of brush head motor [IEC 62885-9]	W	300
Total width of the abrasive pad [IEC 62885-9]	mm	1x340
Central brush head motor RPM	rpm	3800
Weight exerted by the brush head <small>[with strap and brush head; the handle at a distance of one metre from the ground]</small>	kg	7
Gradeability during work GVW	%	2
Solution tank capacity [IEC 62885-9]	l	1
Machine dimensions (length - width - height)	mm	330 320 1290
Battery weight	kg	1,5
Machine net weight [IEC 62885-9]	kg	10
Machine weight during transport [IEC 62885-9]	kg	11
GVW [EN 60335-2-67; IEC 62885-9]	kg	12
Acoustic pressure on the ear of the operator (L _{pA}) [ISO 11201, ISO 4871, EN 60335-2-67]	dB (A)	<70
Uncertainty K _{pA}	dB (A)	1.5
Level of vibration on the arm of the operator [ISO 5349-1, EN 60335-2-67]	m/s ²	< 2.5
Level of vibration on the body of the operator [ISO 5349-1, EN 60335-2-67]	m/s ²	< 0.5
Vibration measurement uncertainty		1.5%

MAIN MACHINE COMPONENTS

The machine's main components are the following:

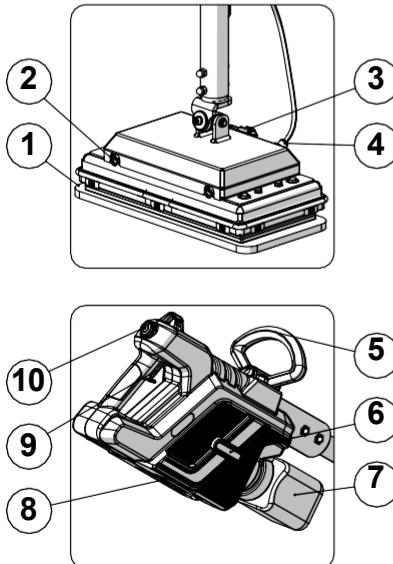

1. Abrasive pad or microfibre pad.
2. Detergent solution dispenser nozzle.
3. Electrical system connector.
4. Water system hose quick coupling.
5. Control handle.
6. Control display.
7. Solution tank.
8. Power supply battery.
9. Detergent solution dispenser button.
10. Machine main switch.

LABELS USED ON THE MACHINE

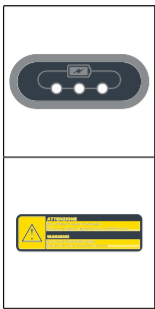

Symbol of battery charge level:

Used near the operator's handle to represent the battery charge level.

Warning symbol:

Used near the nozzle holder support to warn the operator that it is forbidden to use flammable liquids, and that the machine must only be used in closed or covered areas..

PREPARATION OF MACHINE

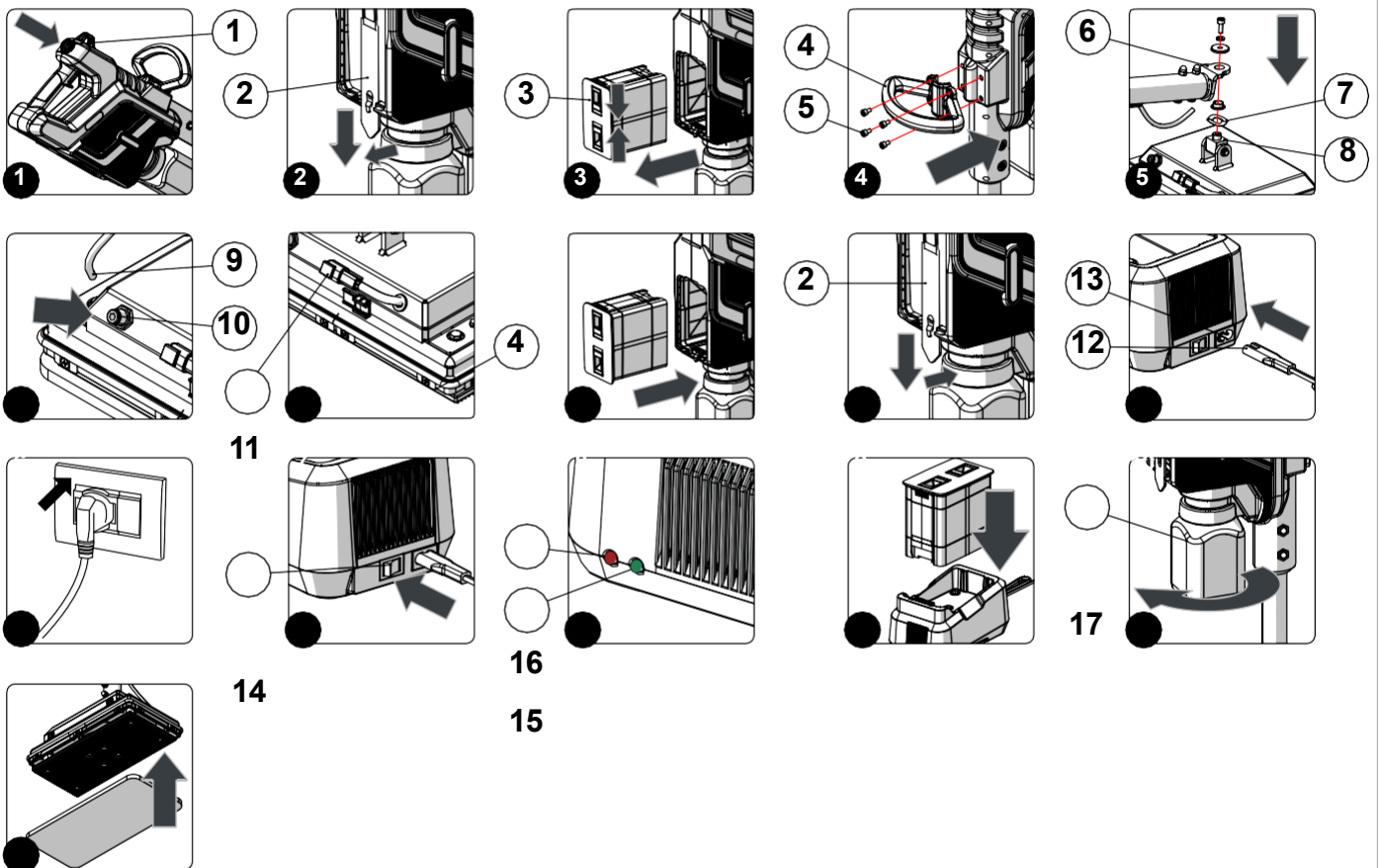

HANDLING THE PACKAGED MACHINE

The overall dimensions of the entire package are: height=30cm width=16cm length=120cm, while the total mass of the packaging is 14Kg.

N.B.: it is recommended that all the packaging components be kept for any future machine transportation.

DANGER: Move the packaged product with handling equipment that complies with legal requirements regarding size and mass of the packaging.

HOW TO UNPACK THE MACHINE

The machine is shipped in specific packaging. To remove it, proceed as follows:

1. Place the lower part of the outer packaging in contact with the floor.

ATTENTION: Use the pictograms printed on the box as reference.

2. Open the outer package.

 **WARNING:** It is recommended to wear the appropriate PPE (Personal Protective Equipment), suitable for the work to be carried out.

3. Take the machine out of the box.

 **ATTENTION:** It is recommended that all the packaging components be kept in case the appliance ever needs transporting.

HOW TO MOVE THE MACHINE

To transport the machine safely, proceed as follows:

 **DANGER:** before starting any task, make sure the current regulations concerning the safe transport of dangerous substances are scrupulously observed.

1. Carry out the steps necessary to secure the machine, see paragraph "MACHINE SAFETY" on page 14.
2. Place the machine on the transport vehicle.

 **WARNING:** secure the device according to the directives in force in the country of use, so that it cannot slide or tip over.

MACHINE SAFETY

The procedure for securing the machine, thus allowing the operations to be performed under conditions of complete safety, is as follows:

1. Make sure the machine is off; if not, press the main switch (1) which is positioned on the rear of the machine (**Fig.1**).

 **N.B.:** The main switch is in the idle position when the LED inside it is off and the activation symbol is not visible.

 **CAUTION:** It is recommended to wear the appropriate PPE (Personal Protective Equipment), suitable for the work to be carried out.

2. Check that the solution tank is empty; if not, empty it. See "ROUTINE MAINTENANCE" on page 18.
3. Remove the battery retainer (2) (**Fig.2**).
4. Remove the power supply battery from the body of the machine, move the retainer levers (3) in the direction of the two arrows and remove the battery from the machine body by moving it outwards. (**Fig.3**).

HOW TO FIT THE CONTROL HANDLE

To secure the control handle on the machine, proceed as follows:

1. Take the machine to the maintenance area.
2. Carry out the steps necessary to secure the machine (see paragraph "MACHINE SAFETY" on page 14).

 **CAUTION:** It is recommended to wear the appropriate PPE (Personal Protective Equipment), suitable for the work to be carried out.

3. Position the control handle (4) in the front part of the machine body, and fasten in place using the screws (5) (**Fig.4**).

 **N.B.:** The equipment to be used for this operation is supplied with the machine packaging.

HOW TO FIT THE BRUSH HEAD BODY

To fit the brush head body to the machine, proceed as follows:

1. Take the machine to the maintenance area.
2. Carry out the steps necessary to secure the machine (see paragraph "MACHINE SAFETY" on page 14).

 **CAUTION:** It is recommended to wear the appropriate PPE (Personal Protective Equipment), suitable for the work to be carried out.

3. Place the brush head body on a flat surface.
4. Fasten the control handlebar (6) above the joint (8) on the brush head body (**Fig.5**).

 **ATTENTION:** Position the compensator ring (7) between the handlebar (6) and the joint (8).

 **N.B.:** The equipment to be used for this operation is supplied with the machine packaging.

5. Insert the detergent solution distribution tube (9) into the quick coupler (10) on the brush head body. (**Fig.6**).
6. Connect the connector on the control handlebar power cable to the connector (11) on the brush head body. (**Fig.7**).

TYPE OF BATTERY TO BE USED

In order to perform to a good standard, the machine must be supplied with 36V of power; we suggest using the 36V 5400mAh battery (code 443147).

BATTERY MAINTENANCE AND DISPOSAL

Please follow the battery manufacturer's instructions for battery maintenance and charging. When the battery is dead, it must be disconnected by a trained specialist.

 **N.B.:** dead batteries are classified as dangerous waste and as such must be delivered to an authorized body for disposal.

INSERTING THE BATTERY INTO THE MACHINE

The battery must be housed in the compartment provided at the rear of the machine.

 **WARNING:** to prevent an accidental short circuit use insulated tools to connect the batteries, and do not place or drop metal objects on the battery. Remove rings, watches and any clothing with metal parts that may come into contact with the battery terminals.

The various phases for inserting the batteries in the battery compartment are as follows:

1. Carry out the steps necessary to secure the machine, see paragraph "MACHINE SAFETY" on page 14.
2. Remove the battery retainer (2) (Fig.2).
3. Insert the battery into the battery compartment at the rear of the machine, ensuring that the battery poles are facing towards the top of the machine (Fig.8).
4. Press down on the battery until the retainers (3) move into position.

 **WARNING:** During this operation, keep the control handlebar still, in order to prevent the machine from moving accidentally.

 **N.B.:** for battery maintenance and daily recharging, you must fully respect the indications provided by the manufacturer or retailer.

 **WARNING:** all installation and maintenance operations must be carried out by specialized personnel.

 **N.B.:** before installing the battery, clean the battery compartment. Check that the connectors on the cables supplied are functioning correctly.

 **ATTENTION:** check that the characteristics of the battery that you are looking to use are appropriate for the type of work to be performed. Check the battery charge and the condition of the contacts on the battery.

 **N.B.:** Before inserting the battery into the machine, check that there is no dirt or moisture in the battery compartment.

5. Position the battery retainer (2) (Fig.9).

RECHARGING THE BATTERY

The battery must be charged prior to the first use, and when it doesn't provide enough power for tasks that could formerly be performed without difficulty.

 **ATTENTION:** To prevent permanent damage to the battery, it is essential to prevent complete discharge thereof; this must be done by charging the battery within a few minutes of the low battery signal being activated.

 **ATTENTION:** Never leave the battery completely discharged, even if the machine is not in use.

1. Bring the machine to the battery recharging area.
2. Carry out the steps necessary to secure the machine, see paragraph "MACHINE SAFETY" on page 14.











 **ATTENTION:** park the machine in an enclosed place, on a flat and level surface; near the machine there must be no objects that could either damage it, or be damaged through contact with it.

 **ATTENTION:** The space used for charging the battery must be adequately ventilated.

3. Connect the plug on the charger power cable (12) to the socket at the base of the battery charger (13). (Fig.10).
4. Connect the plug on the charger power cable to the power socket (Fig.11).

 **ATTENTION:** Before connecting the plug to the socket, check that the characteristics of the mains supply correspond with those of the battery charger (please refer to the document provided with the machine).

5. Move the main switch (14), on the base of the battery charger, to position "I" (Fig.12).

-  **ATTENTION:** Ensure that the green LED (15) on the battery charger lights up when you connect the battery charger base circuit to the power (Fig.13). This LED indicates that the battery charger circuit is correctly powered.
-  **ATTENTION:** Before inserting the battery into the charging holder, check that there is no condensation or other liquid in the dock that will hold the battery.
- 6. Insert the battery into the slot provided in the charger, taking care to position the battery poles correctly (Fig.14).
 -  **ATTENTION:** The battery can only be inserted into the charger one way. Do not use force when inserting the battery.
 -  **ATTENTION:** Carefully read the battery charger use and maintenance manual delivered with the appliance, before charging the battery.
 -  **ATTENTION:** Check that, when inserting the battery into the base of the battery charger, the red LED (16) present on the battery charger (Fig.13) turns on. This LED indicates that the battery is recharging.
- 7. Perform a complete battery charging cycle.
 -  **ATTENTION:** the red LED (16) remains on until the battery is fully charged.
 -  **ATTENTION:** The charger and the battery can be left connected to the power outlet. The red LED (16) lights up when the charger occasionally tops up the battery.
 -  **ATTENTION:** the red charge status LED (16) does not provide any indication of the battery charge level.
 -  **ATTENTION:** The battery may overheat during the charging phase, nevertheless, this is normal and does not imply that there is a problem with the battery.
 -  **ATTENTION:** If the battery used in this device is over-charged, this may present a risk of fire, explosion or chemical burns.
- 8. When charging is complete, position the main switch (14), on the base of the battery charger, to position "0" (Fig.12).
- 9. Disconnect the battery charger power supply cable plug from the mains socket.
 -  **ATTENTION:** To prevent damaging the power cable, disconnect the plug from the mains socket by directly pulling the plug and not the cable.
- 10. Remove the power supply battery from the body of the charger base, remove the battery from the body of the appliance by moving it upwards.

FILLING THE SOLUTION TANK

Before filling the solution tank, carry out the following steps:

1. Take the machine to the usual place for filling the solution tank.
2. Carry out the steps necessary to secure the machine, see paragraph "MACHINE SAFETY" on page 14.
3. Unscrew the solution tank from the machine body (17) (Fig.15).
4. Fill with clean water, at a temperature no higher than 50°C and no lower than 10°C.
5. After filling the solution tank with clean water add the liquid detergent to the tank in the concentration and manner indicated on the detergent manufacturer's label. To prevent the formation of excessive amounts of foam, use the minimum percentage of detergent recommended.

 **WARNING:** protective gloves should always be worn before handling detergents or acidic or alkaline solutions, to avoid serious injury to the hands.

 **ATTENTION:** always use detergents whose manufacturer's label indicates their suitability for scrubbing machines. Do not use acid or alkaline products or solvents without this indication.

 **ATTENTION:** always use low-foam detergent. Do not use pure acids.

6. When the tank is full, repeat the operations in reverse order in order to reassemble everything.

ASSEMBLING THE ABRASIVE PAD

For packaging reasons, the abrasive pad comes disassembled from the machine (if requested on the purchase order), and must be assembled on the brush head body by doing the following:

1. Carry out the steps necessary to secure the machine, see paragraph "MACHINE SAFETY" on page 14.

 **WARNING:** It is recommended to wear the appropriate PPE (Personal Protective Equipment), suitable for the work to be carried out.

2. Lay the machine on the ground and place the pad you want to use on the bottom of the support (Fig.16).

PREPARING TO WORK

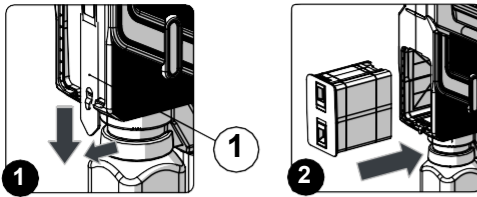

Before beginning to work, it is necessary to:

1. Check that the quantity of detergent solution present in the solution tank is suitable for the type of work to be carried out. If this is not the case, fill the solution tank; see FILLING SOLUTION TANK.
2. Check that the condition of the abrasive pad is suitable for the work to be carried out; if it is worn, replace it. See FITTING THE ABRASIVE PAD.
3. Carry out the steps necessary to secure the machine, see paragraph "MACHINE SAFETY" on page 14.
4. Remove the battery retainer (1) (Fig.1).
5. Insert the battery into the battery compartment at the rear of the machine, ensuring that the battery poles are facing towards the top of the machine (Fig.2).
6. Press down on the battery until the retainers move into position.

STARTING WORK

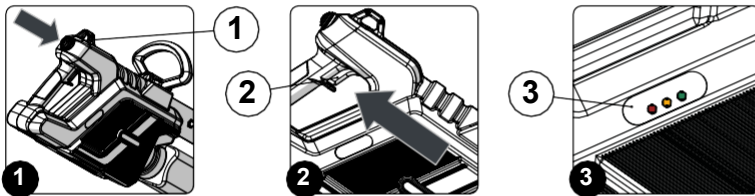

1. Carry out all the checks listed in the chapter "PREPARING TO WORK" on page 17.
2. Switch the machine on, by pressing the main switch (1) located at the rear of the machine (Fig.1).

i **N.B.:** The main switch is in the working position when the LED inside it is on and the activation symbol is visible.

⚠ **ATTENTION:** As soon as the machine is switched on, the motor in the brush head body will start working.

3. Pressing the detergent solution pump control button (2) (Fig.2) will dispense the detergent solution in front of the brush head body.

i **N.B.:** When the button (2) is released, the flow of detergent solution will stop.

i **N.B.:** During the first few metres of work, check that the quantity of solution is sufficient to wet the floor.

i **N.B.:** The machine will now begin to work with full efficiency until the battery is flat or until the detergent solution has finished.

BATTERY CHARGE LEVEL INDICATOR

The control display (3) (Fig.3) is located on the right-hand side of the machine body; this features three LEDs of different colours, each of which is associated with a percentage of battery charge.

Battery level	LED on
>25%	Green
>15%	Yellow
≤15%	Red

i **N.B.:** After a few seconds of the battery charge reaching the critical 10% level, the brush head motor will automatically switch off if active.

ALARM SIGNALLING DEVICE

When an error occurs on the control display (3) (**Fig.3**) the LEDs on this will start flashing in accordance with a precise sequence; they will continue to flash until the error itself is resolved.

- i** **N.B.:** when the machine is in alarm status, the following codes are displayed on the control display:
- the number of flashes of the red LED correspond with the first digit of the alarm code;
 - the number of flashes of the yellow LED correspond with the second digit of the alarm code;

When an error occurs, do as follows:

1. Stop the machine immediately.
2. If the error persists, switch off the machine, wait for at least ten seconds and switch on the machine.
3. If the error persists contact the nearest service center.

List of alarms:

NUMBER	TYPE	DESCRIPTION
AL_1	General	Memory error
AL_2	General	Key fault
AL_3	General	Undervoltage
AL_4	General	Overvoltage
AL_7	General	FFM communication
AL_41	Function	Overtemperature
AL_42	Function	Power board damaged

NUMBER	TYPE	DESCRIPTION
AL_44	Function	Main contactor faulty
AL_45	Function	Main contactor faulty - CC
AL_46	Function	Overcurrent - brush outputs 1-2-3
AL_49	Function	Amperometric - brush output 1
AL_52	Function	Amperometric - vacuum cleaner output 1
AL_54	Function	Brush 1 not connected
AL_57	Function	Vacuum 1 not connected

AT THE END OF THE WORK

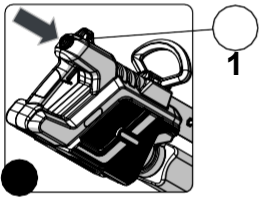

At the end of the work, and before carrying out any type of maintenance, perform the following operations:

1. Switch the machine on, by pressing the main switch (1) located at the rear of the machine (**Fig.1**).

- i** **N.B.:** The main switch is in the idle position when the LED inside it is off and the activation symbol is not visible.

2. Take the appliance to the dedicated dirty water drainage area.
3. Carry out all the procedures listed in the chapter "ROUTINE MAINTENANCE" on page 18.
4. Once the routine maintenance operations are complete, take the machine to the designated storage location.

- ⚠** **ATTENTION:** Park the machine in an enclosed place, on a flat surface, and at a safe distance from any objects that could either damage it or be damaged due to contact with the machine itself.

5. Secure the machine, see paragraph "MACHINE SAFETY" on page 14.

ROUTINE MAINTENANCE

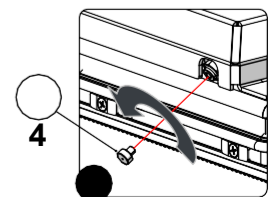
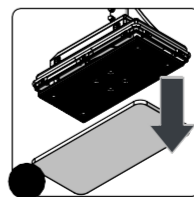
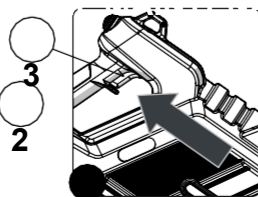
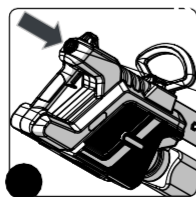
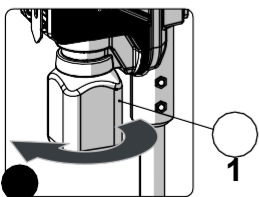

At the end of the working day, carry out the following steps:

1. Take the machine to the maintenance area.

- ⚠** **WARNING:** The place designated for this operation must comply with current regulations concerning safety at work and current environmental protection regulations.

 **WARNING:** It is recommended to wear the appropriate PPE (Personal Protective Equipment), suitable for the work to be carried out.

2. Unscrew the solution tank (1) from the machine (**Fig.1**).
3. Empty the solution tank.

 **N.B.:** the place designated for this operation must comply with current environmental protection regulations.

4. When the solution tank is clean, fill it with water and reposition it in the body of the machine.
5. Switch the machine on, by pressing the main switch (2) located at the rear of the machine (**Fig.2**).

 **N.B.:** The main switch is in the working position when the LED inside it is on and the activation symbol is visible.

6. Activate the detergent solution delivery pump by pressing the pump control button (3) located near the handle (**Fig.2**).
7. Leave the pump active until all impurities have been removed from the water system circuit.
8. At the end of this operation, release the button (3) and switch off the machine by pressing the switch (2).

 **N.B.:** The main switch is in the idle position when the LED inside it is off and the activation symbol is not visible.

9. Unscrew the solution tank (1) and empty it.

 **N.B.:** Rinse the inside of the tank with running water; in case of stubborn dirt, use a brush with soft bristles to remove any impurities.

10. When the inside of the tank is clean, dry it with a microfibre cloth and refit it on the body of the machine.
11. Carry out the steps necessary to secure the machine, see paragraph "MACHINE SAFETY" on page 14.
12. With the brush head body raised, remove the pad from the support (**Fig.4**) and clean it.

 **N.B.:** Rinse the abrasive pad with running water; in case of stubborn dirt, use a brush with soft bristles to remove any impurities.

13. When the abrasive pad is dry, refit it on the brush head body; see "ASSEMBLING THE ABRASIVE PAD" on page 16.
14. With the brush head body positioned on the ground, unscrew the nozzles (4) on the front part of the brush head body (**Fig.5**).
15. Immerse these in a descaling solution.

 **ATTENTION:** Only use descaling products; some chemical products may damage the surfaces of the parts. Carefully read the instructions for use provided by the manufacturer of the chemical selected.

16. When the nozzles are clean, rinse them with running water.

 **N.B.:** Rinse the nozzles with running water; in case of stubborn dirt, use a brush with soft bristles to remove any impurities.

17. When the nozzles are clean, dry them with a microfibre cloth and refit them on the brush head body.

DISPOSAL



Dispose of the machine in accordance with the waste disposal regulations in force in the country in which the machine is being used.

CHOOSING AND USING THE PAD

RED PAD

Suitable for frequent use on relatively clean floors. Even cleans without water, and polishes by removing marks.

WHITE PAD

Suitable for finishing treated floors and for shiny polishing. Use dry or slightly damp.

BROWN PAD

Suitable for wet or dry scraping with wax removers. Prepare the floor for new waxing. Resistant to acids.

CODE	QTY	WIDTH [cm]	LENGTH [cm]	NOTES
453208	1	34	16	RED ABRASIVE PAD
453410	1	34	16	BROWN ABRASIVE PAD
453411	1	34	16	WHITE ABRASIVE PAD
453412	1	35	16	MICROFIBRE PAD

TROUBLESHOOTING

This chapter lists the most common problems linked with the use of the machine. If you are unable to resolve the problems with the information given here, please contact your nearest assistance center.

PROBLEM	POSSIBLE CAUSE	SOLUTION
THE MACHINE DOES NOT START	The main switch is OFF.	Check that the main switch is on; if not, press it.
	An alarm sequence appears on the control display when it is switched on.	Stop the machine immediately, and contact a specialized service center.
	The battery is not correctly inserted into the machine.	Insert the battery correctly, see "INSERTING THE BATTERY INTO THE MACHINE" on page 15
	The battery charge level is low.	If the battery charge level is critical, carry out a full charging cycle. See "RECHARGING THE BATTERY" on page 15
THE BATTERY IS NOT PROPERLY FITTED	The charger cable connector is not correctly plugged into the socket on the base of the battery charger.	Try reconnecting the charger cable connector to the socket on the base of the battery charger.
	The battery charger power cable plug is not properly plugged into the mains socket.	Connect the battery charger power cable plug to the mains socket.
	The characteristics of the power supply network do not correspond with those required by the battery charger.	Check that the electrical characteristics on the battery charger plate are the same as those of the mains supply system.
	The LEDs of the battery charger blink repeatedly.	Referring to the use and maintenance manual for the battery charger, check what the flashing lights on the charger during battery charging mean.
THE MACHINE HAS A VERY LOW WORK AUTONOMY	Check the battery charge level; check the symbol on the control display.	If the battery charge level is critical, carry out a full charging cycle. See. "RECHARGING THE BATTERY" on page 15
THE AMOUNT OF DETERGENT SOLUTION ON THE BRUSH HEAD BODY IS INADEQUATE	The quantity of detergent solution present in the solution tank is not suitable for the type of work to be carried out.	Fill the solution tank; see "FILLING THE SOLUTION TANK" on page 16.
	The nozzles on the brush head body are blocked.	Clean the nozzles and the entire machine water system; see "ROUTINE MAINTENANCE" on page 18
THE MACHINE DOES NOT CLEAN CORRECTLY	The machine does not start.	Read the section "THE MACHINE DOES NOT START".
	Not enough detergent solution comes out.	See the section "THE AMOUNT OF DETERGENT SOLUTION ON THE BRUSH HEAD BODY IS INADEQUATE".
	The pad has not been correctly inserted into the machine.	Position the pad correctly.
	The type of pad in use is not suitable for the dirt to be tackled.	Check that the pad selected is suitable for the work to be carried out; for help, contact the nearest technical assistance center.
	The pad is excessively worn.	Check the state of wear of the brush and, if necessary, replace it.
EXCESSIVE FOAM PRODUCTION	The detergent being used is not suitable.	Check that a low foam detergent has been used.
	The floor is not very dirty.	Dilute the detergent more.

EC DECLARATION OF CONFORMITY



The undersigned manufacturer:

FIMAP S.p.A.
Via Invalidi del Lavoro, 1
37059 Santa Maria di Zevio (VR)

declares under its sole responsibility that the products

SINGLE DISC MACHINE
mod. ORBITIZER

comply with the requirements of the following Directives:

2006/42/EC: Machinery Directive.
2014/30/EU: Electromagnetic compatibility directive.
2011/65/EU: RoHS

They also comply with the following standards:

EN 60335-1:2012/A11:2014
EN 60335-2-67:2012
EN 12100:2010
EN 55014-1:2006/A1:2009/A2:2011
EN 55014-2:2015
EN 62233:2008/AC:2008

The person authorized to compile the technical file:

Mr. Giancarlo Ruffo
Via Invalidi del Lavoro, 1
37059 Santa Maria di Zevio (VR) - ITALY

Santa Maria di Zevio (VR), 10/09/2018

Fimap S.p.A.
Legal representative
Giancarlo Ruffo



FIMAP S.p.A. - Via Invalidi del Lavoro, 1 - 37059 S. Maria di Zevio - Verona - Italy
Tel. +39 045 6060411 – Fax +39 045 6060417 – E-mail:fimap@fimap.com
www.fimap.com